

# INSTRUCTION MANUAL



Advanced 1000-3 Orbital Shaker  
Advanced 1000MP Microplate Shaker



## TABLE OF CONTENTS

Package Contents	1
Warranty	1
Installation	2
Maintenance & Servicing	2
Equipment Disposal	2
Environmental Conditions	2
Safety Instructions	3
Standards & Regulations	3
Control Panel	4
Advanced 1000-3 Orbital Shaker	5-6
Advanced 1000MP Microplate Shaker	7-8
Operating Instructions	9-10
Troubleshooting	10
Replacement Parts	11-12
Accessories	13-14

### PACKAGE CONTENTS

---

Advanced 1000-3 Orbital Shaker or Advanced 1000MP Microplate Shaker  
Non-skid rubber mat (Orbital Shaker only)  
92" (234cm) detachable power cord  
Instruction manual  
Warranty card

### WARRANTY

---

Manufacturer warrants this product to be free from defects in material and workmanship when used under normal conditions for five (5) years. Please complete and return the enclosed warranty card. For your reference, make a note of the serial number, date of purchase and supplier here.

Serial Number: \_\_\_\_\_

Date of Purchase: \_\_\_\_\_

Supplier: \_\_\_\_\_

## INSTALLATION

---

Upon receiving the Talboys Orbital/Microplate Shaker, check to ensure that no damage has occurred during shipment. It is important that any damage that occurred in transport is detected at the time of unpacking. If you do find such damage the carrier must be notified immediately.

After unpacking, place the Orbital/Microplate Shaker on a level bench or table, away from explosive vapors. Secure to an immovable work surface by pressing down on the four (4) corners of the unit, creating a strong suction to the work surface (**DO NOT** place on a bench mat). Ensure that the surface on which the unit is placed will withstand typical heat produced by the unit. Always place the unit on a sturdy work surface.

The Orbital/Microplate Shaker is supplied with a power cord that is inserted into the IEC connector on the back of the unit first, then it can be plugged into a properly grounded outlet. The 120V unit plugs into a 120 volt, 50/60 Hz source. The 230V unit plugs into a 230 volt, 50/60 Hz source.

## MAINTENANCE & SERVICING

---

The Orbital/Microplate Shaker is built for long, trouble-free, dependable service. No lubrication or other technical user maintenance is required. However at least every three (3) months you should:

- Unplug the unit.
- Remove any accumulated dirt from the base and tray.
- Check all accessible items to make sure they are properly tightened.

The unit should be given the care normally required for any electrical appliance. Avoid wetting or unnecessary exposure to fumes. Spills should be removed promptly. **DO NOT** use a cleaning agent or solvent on the front panel which is abrasive or harmful to plastics, nor one which is flammable. Always ensure the power is disconnected from the unit prior to any cleaning. If the unit ever requires service, contact your Talboys representative.

## ENVIRONMENTAL CONDITIONS

---

**Operating Conditions:** Indoor use only.

\*For use in CO<sub>2</sub> environments, incubators or cold rooms.

\*Temperature: -10 to 60°C (14 to 140°F)

Humidity: maximum 80% relative humidity, non-condensing

Altitude: 0 to 6,562 ft (2000 M) above sea level

**Non-Operating Storage:**

\*Temperature: -20 to 65°C (-4 to 149°F)

Humidity: maximum 80% relative humidity, non-condensing

Installation Category II and Pollution Degree 2 in accordance with IEC 664.

\* **Avoid cold starts:** Unit is not designed to start after being in a cold room environment. Bring unit into cold room from a room temperature environment, operate and remove unit from cold room as soon as operation is complete.

## EQUIPMENT DISPOSAL

---

This equipment must not be disposed of with unsorted waste. It is your responsibility to correctly dispose of the equipment at life-cycle-end by handing it over to an authorized facility for separate collection and recycling. It is also your responsibility to decontaminate the equipment in case of biological, chemical and/or radiological contamination, so as to protect the persons involved in the disposal and recycling of the equipment from health hazards.



For more information about where you can drop off your waste of equipment, please contact your local dealer from whom you originally purchased this equipment. By doing so, you will help to conserve natural and environmental resources and you will ensure that your equipment is recycled in a manner that protects human health.

## SAFETY INSTRUCTIONS

---

Please read the entire instruction manual before operating the Orbital/Microplate Shaker.



**WARNING! DO NOT** use the Orbital/Microplate Shaker in a hazardous atmosphere or with hazardous materials for which the unit was not designed. Also, the user should be aware that the protection provided by the equipment may be impaired if used with accessories not provided or recommended by the manufacturer, or used in a manner not specified by the manufacturer.

Always operate unit on a level surface for best performance and maximum safety.

**DO NOT** lift unit by the tray.



**CAUTION!** To avoid electrical shock, completely cut off power to the unit by disconnecting the power cord from the unit or unplugging from the wall outlet. Disconnect unit from the power supply prior to maintenance and servicing.

Spills should be removed promptly. **DO NOT** immerse the unit for cleaning.

**DO NOT** operate the unit if it shows signs of electrical or mechanical damage.



Earth Ground - Protective Conductor Terminal



Alternating Current

## STANDARDS & REGULATIONS

---

Henry Troemner LLC hereby declares under its sole responsibility that the construction of this product conforms in accordance with the following standards:

### Safety standards:

IEC 61010-1	Safety requirements for electrical equipment for measurement, control and laboratory use. Part I: General Requirements.
IEC 61010-2-010	Part II: Particular requirements for laboratory equipment for the heating of materials.
IEC 61010-2-051	Part II: Particular requirements for laboratory equipment for mixing and stirring.

UL Std. No. 61010-1

CSA/CAN C22.2 No. 0-M91

CSA/CAN C22.2 No. 61010-1-04

### EMC standards:

FCC-B	EN55022-B
EN6100-3-3	EN6100-4-5
EN61000-4-2	EN61000-4-3
EN61000-4-4	EN61000-4-6
EN61000-4-11	EN61326-1 Class A

### Associated EU guidelines:

EMC directive 2004/108/EEC

LVD directive 2006/95/EEC

RoHS directive 2011/65/EU

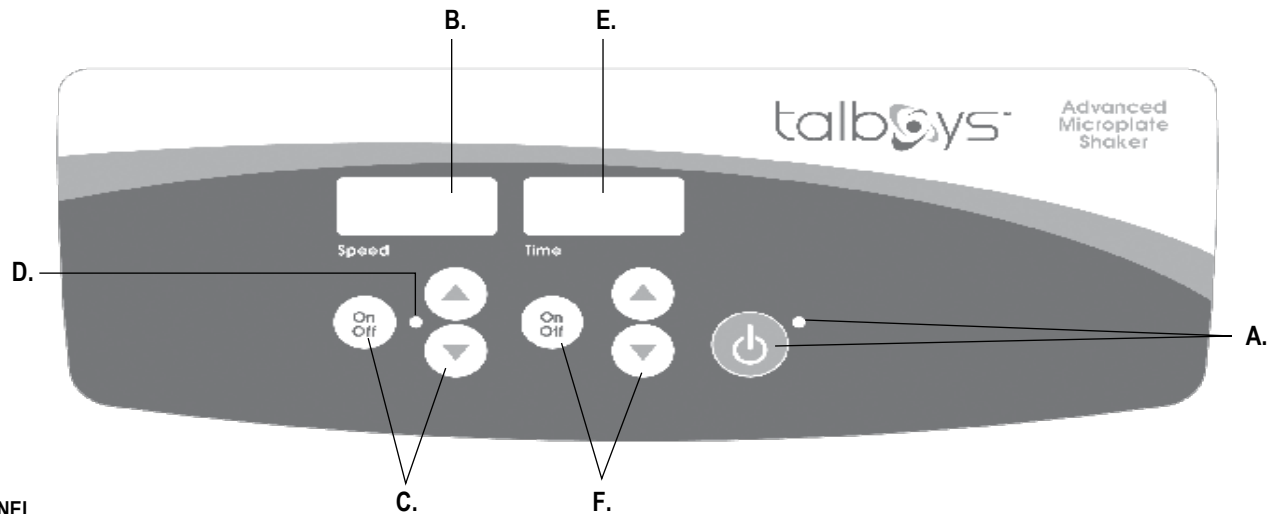

## CONTROL PANEL

The front panel of the Orbital/Microplate Shaker contains all the controls and displays needed to operate the unit.

**A. Standby button/standby indicator light:** The standby indicator light will illuminate when the unit is plugged in. The unit will be in standby mode. Press the standby button to activate the speed and time functions. The standby indicator light will shut off and the speed display and time display will illuminate. Press the standby button again and the unit will once again be in standby mode.

**B. Speed display:** Displays the speed of the shaker. **C. Up/down arrows for set-point control.** On/off button starts/stops shaking function. **D. The speed indicator light** will be illuminated when the unit is shaking.

**E. Time display:** Displays accumulated time (continuous mode) or how much time is remaining (timed mode). The display range is from 0 to 9,999 minutes in one (1) second increments. The display will indicate minutes and seconds until the timer reaches 99 minutes and 59 seconds (99:59), then the display will automatically display minutes up to 9,999.

**F. Up/down arrows for set-point control.** On/off button starts/stops the time function.

## ADVANCED 1000-3 ORBITAL SHAKER SPECIFICATIONS



Advanced 1000-3  
Orbital Shaker  
with plasticware

<b>Overall dimensions (L x W x H):</b>	17 x 11 x 4" (43.2 x 27.9 x 10.2cm)
<b>Tray dimensions (L x W):</b>	11.75 x 7.75" (29.9 x 19.7cm)
<b>Electrical (50/60 Hz):</b>	120 volts: 5 amps, 25 watts 230 volts: 5 amps, 25 watts
<b>Fuses:</b>	5mm x 20mm, 5 amp quick acting
<b>Speed range:</b>	100 to 1200rpm
<b>Speed accuracy:</b>	±2%
<b>Timer:</b>	1 second to 9999 minutes (increased in 1 second increments)
<b>Orbit:</b>	0.125" (3mm)
<b>Maximum weight capacity:</b>	~ 8lbs (3.6kg), up to 1000rpm ~ 5lbs (2.3kg), over 1000rpm
<b>Controls:</b>	see page 4
<b>Tray material:</b>	aluminum
<b>Ship weight:</b>	25lbs (11.4kg)

## ADVANCED 1000-3 ORBITAL SHAKER SET-UP

The Orbital Shaker is supplied with a tray designed to hold a variety of accessories.

1. Flat containers can be shaken by placing them on the non-skid rubber mat provided with the unit.
2. The tray also has mounting holes ready for use with flask/media bottle clamps or test tube racks. See below for tray configurations.

## ADVANCED 1000-3 ORBITAL SHAKER TRAY CONFIGURATIONS

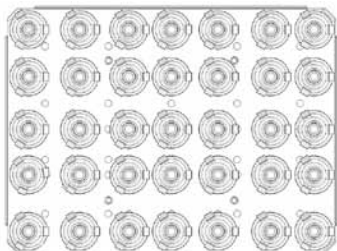

(35) 10mL Erlenmeyer Flask Clamps

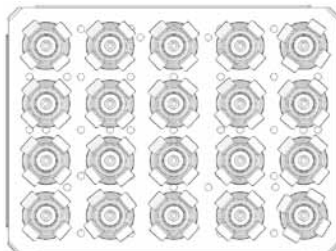

(20) 25mL Erlenmeyer Flask Clamps

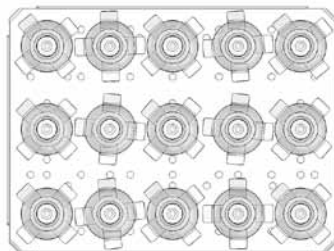

(15) 50mL Erlenmeyer Flask Clamps

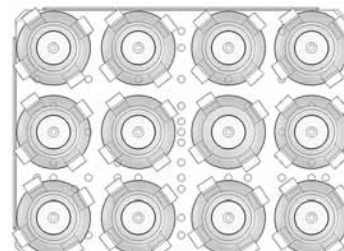

(12) 125mL Erlenmeyer Flask Clamps

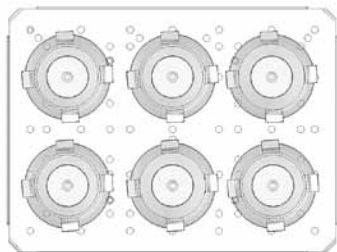

(6) 250mL Erlenmeyer Flask Clamps

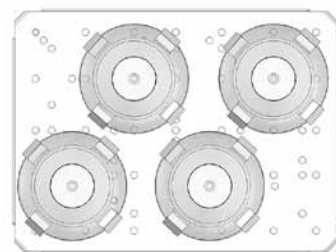

(4) 500mL Erlenmeyer Flask Clamps

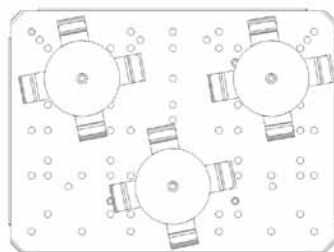

(3) 500mL Media Bottle Clamps

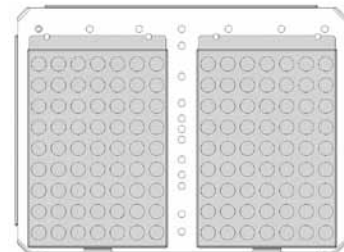

(2) Test Tube Racks

## ADVANCED 1000MP MICROPLATE SHAKER SPECIFICATIONS

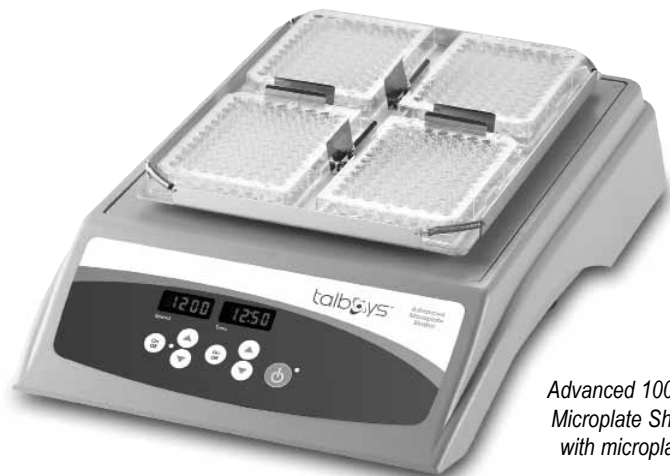

*Advanced 1000MP  
Microplate Shaker  
with microplates*

<b>Overall dimensions (L x W x H):</b>	17 x 11 x 4" (43.2 x 27.9 x 10.2cm)
<b>Tray dimensions (L x W):</b>	11 x 7.75" (27.9 x 19.7cm)
<b>Electrical (50/60 Hz):</b>	120 volts: 5 amps, 25 watts 230 volts: 5 amps, 25 watts
<b>Fuses:</b>	5mm x 20mm, 5 amp quick acting
<b>Speed range:</b>	100 to 1200rpm
<b>Speed accuracy:</b>	±2%
<b>Timer:</b>	1 second to 9999 minutes (increased in 1 second increments)
<b>Orbit:</b>	0.125" (3mm)
<b>Capacity:</b>	4 microplates or 2 micro-tube racks
<b>Controls:</b>	see page 4
<b>Tray material:</b>	aluminum
<b>Ship weight:</b>	25lbs (11.4kg)



## ADVANCED 100MP MICROPLATE SHAKER SET-UP

The Microplate Shaker is designed to hold two (2) or four (4) microplates, or two (2) Micro-Tube Racks.

1. Place two (2) microplates or deep well blocks diagonally on the tray, or place four (4) microplates or deep well blocks on the tray. The plates/blocks do not have to be filled.
2. Place the corner of the plate/block under the spring located at each corner of the tray.
3. Slide plate/block into place. You are ready to use.

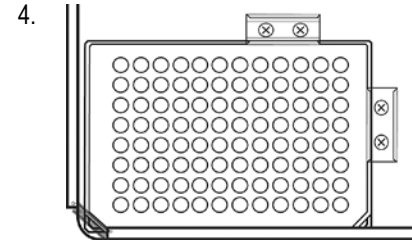
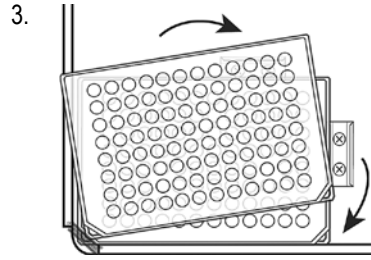
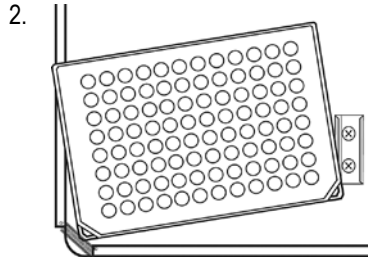

## ADVANCED 100MP MICROPLATE SHAKER TRAY CONFIGURATIONS

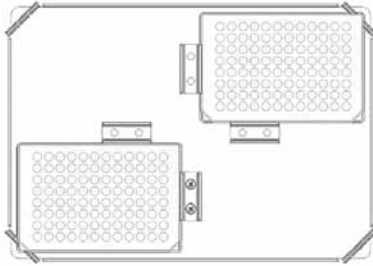

(2) microplates

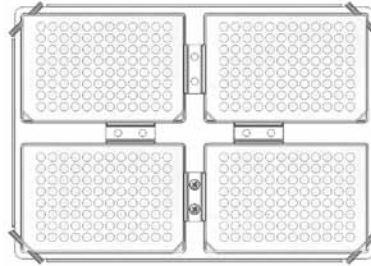

(4) microplates

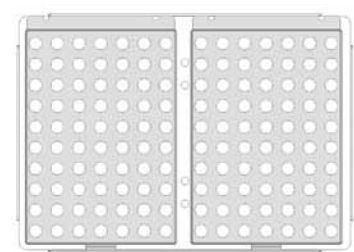

(2) Micro-Tube Racks

**NOTE:** The tray on the Microplate Shaker is not designed to hold flask clamps.

## ADVANCED ORBITAL/MICROPLATE SHAKER OPERATING INSTRUCTIONS

---

The Orbital/Microplate Shakers have been designed for the speed and time functions to work independently of one another. The speed can be reset without resetting the timer and the timer can be stopped and started without interrupting the shaking function.

### 1. Getting ready:

- a. Plug the power cord into a properly ground outlet. The standby indicator light will illuminate, verifying power to the unit.
- b. Press the standby button to move the unit from standby mode. The standby indicator light will turn off and the speed and time displays will illuminate, displaying previously used settings.



### 2. Setting speed:

- a. Press the up/down arrows below the speed display until you reach the desired speed. When you release the button, the display will blink off and then on indicating the new set speed has been accepted.
- b. Press the on/off button to start the shaking function. The indicator light below the speed display will illuminate to indicate the shaking function is in use and remain lit until shaking has ceased. The microprocessor controlled ramping feature slowly increases speed until the set-point is reached which helps to avoid splashing, and provides excellent low end control.
- c. Speed adjustments can be made without interrupting shaking by using the up/down arrows below the speed display. After the change has been made and you release the button, the display will blink off and then on indicating the new set speed has been accepted.
- d. To stop the shaking function, press the on/off button below the speed display. The speed indicator light will turn off.

### 3. Setting time to zero (0:00) and continuous mode: Accumulated time.

- a. Press and hold the on/off button below the time display. After three (3) seconds the display will indicate the previous set time.

- b. Simultaneously press both the up and down arrows, the display will indicate zero (0:00). The unit time is now set to zero (0:00) minutes. Alternately, you can use the up/down arrows to get to zero (0:00).
- c. Press the on/off button below the time display. The display will indicate accumulated time. The up/down arrows will become inactive. To stop timer, press the on/off button again. **IMPORTANT:** This will **NOT** interrupt the shaking function. Press the on/off button below the speed display to interrupt the shaking function.
- d. To reset, press and hold the on/off button below the time display. After three (3) seconds the display will indicate the previous set time, which was zero (0:00).

### 4. Setting timed mode: Programmed time.

- a. Press the up/down arrows below the time display until you reach the desired time.
- b. Start this function by pressing the on/off button below the time display. The unit will run for the selected time, the up/down arrows will become inactive while the timer is running. The unit will stop shaking when the time display reaches zero (0:00). Four (4) audible beeps will indicate the count down function is complete. The time display will default back to the set time. To repeat for the same time, simply press the on/off button again.
- c. To interrupt an automatic timing cycle before it is completed, press the on/off button below the time display. The display will flash off and on to indicate the time function is on "hold". **IMPORTANT:** This will **NOT** interrupt the shaking function. Press the on/off button below the speed display to interrupt the shaking function. Restart the timer by pressing the on/off button below the time display. Unit will continue counting down to zero (0:00). When the display reaches zero (0:00), you will hear the four (4) audible beeps that indicate the count down function is complete and shaking function will cease.

## OPERATING INSTRUCTIONS CONT'D

---

### 5. Turning unit off:

- a. To turn the unit off, press the standby button. The speed and time displays will be blank, the standby indicator light will illuminate. The Orbital/Microplate Shaker should be kept in standby mode when not in use. To completely cut off power to the unit, disconnect the power cord from the unit or unplug from the wall outlet.

### OPERATING TIPS

As a safety feature, a built-in program will shut power off to the motor if the tray is prevented from rotating, or the unit is overloaded beyond its recommended weight capacity.

Built-in memory maintains the last used speed and time settings during a power interruption.

## TROUBLESHOOTING

---

During operation, any rattling or ticking sounds may indicate a loose screw on the tray, a tray attachment or an accessory. All accessories should be sufficiently tightened in place before starting the unit.

<u>Error Code</u>	<u>Software Test</u>	<u>Cause</u>
E04	unit overloaded	maximum load exceeded loose foot (suction cup)*

Press the standby button to clear this error. Be sure the load is within the maximum load capacity before restarting the unit. If the E04 error persists, switch the unit off and contact your Talboys representative for repairs.

<u>Error Code</u>	<u>Software Test</u>	<u>Cause</u>
E03	drive system failure	ceased bearing drive belt broken mechanical obstruction loose foot (suction cup)*

Press the standby button to clear this error and remove the mechanical obstruction. If the E03 error persists the reason may be a ceased bearing or broken drive belt and should **NOT** be addressed by the end user. Switch the unit off and contact your Talboys representative for repairs.

\*In the event a foot (suction cup) has come loose from the bench top, the unit will register an errant E04 or E03 error message due to the instability of the unit. Press the standby button to clear this error. Firmly press down on the four (4) corners of the unit, creating a strong suction to the work surface (**DO NOT** place on bench mat). Press the standby button to resume operation.

## ADVANCED 1000-3 ORBITAL SHAKER REPLACEMENT PARTS

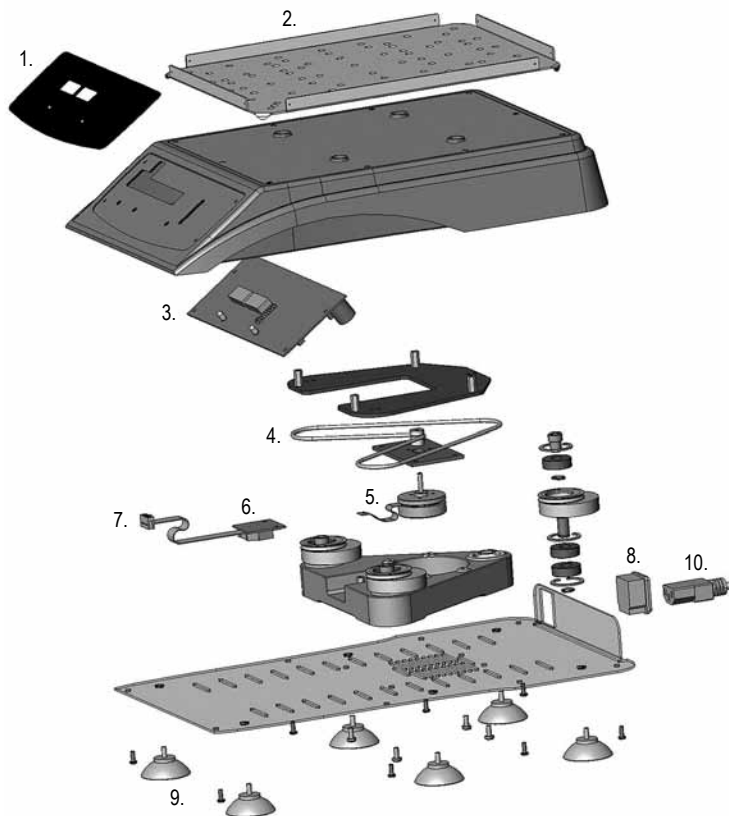

DESCRIPTION	PART NUMBER
1. Front panel membrane switch	385703-00
2. Tray	580050-00
3. Display board	380780-00
4. Belt	580019-00
5. Motor	380712-00
6. Motor transition board	380415-00
7. Connection cable	380720-00
8. IEC power entry module	386122-00
9. Feet (suction cup)	545014-00
10. Detachable 92" (234cm) power cord:	
120V	330100-00
Euro plug	330101-00
UK	330102-00
Swiss plug	330103-00

## ADVANCED 1000MP MICROPLATE SHAKER REPLACEMENT PARTS

DESCRIPTION	PART NUMBER
1. Front panel membrane switch	385702-00
2. Tray assembly	880761-00
3. Display board	380780-00
4. Belt	580019-00
5. Motor	380712-00
6. Motor transition board	380415-00
7. Connection cable	380720-00
8. IEC power entry module	386122-00
9. Feet (suction cup)	545014-00
10. Detachable 92" (234cm) power cord:	
120V	330100-00
Euro plug	330101-00
UK	330102-00
Swiss plug	330103-00

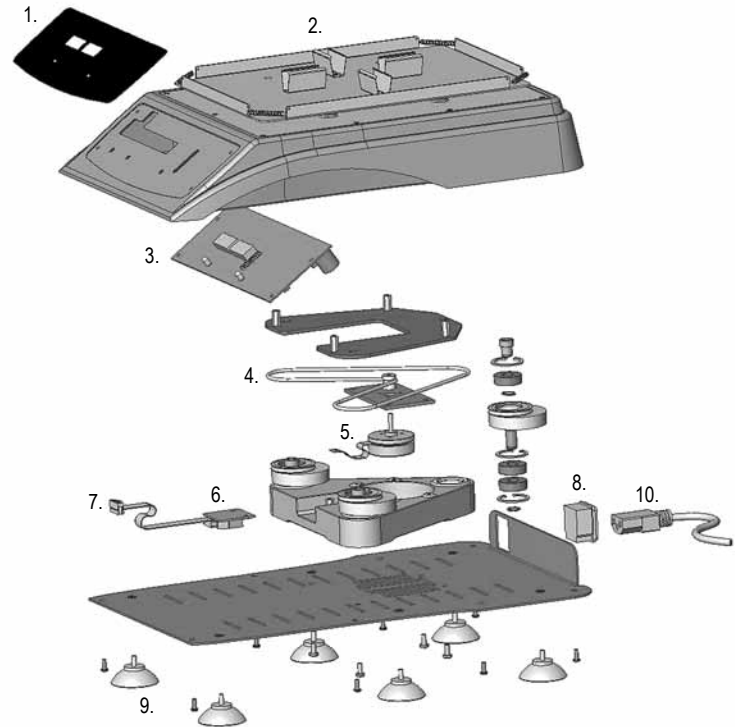

## ACCESSORIES

### TEST TUBE RACKS

DESCRIPTION	TUBE CAPACITY	PLATFORM CAPACITY	PART NUMBER
10 to 13mm Test Tube Rack	63	2	980193
14 to 16mm Test Tube Rack	48	2	980194
18 to 20mm Test Tube Rack	35	2	980195
22 to 25mm Test Tube Rack	24	2	980196
15mL Centrifuge Tube Rack	42	2	980198
50mL Centrifuge Tube Rack	12	2	980199
1.5 to 2mL Micro-Tube Rack	70	2	980191

#### Installation of Test Tube Racks - Orbital Shaker

1. Unit should be in standby mode.
2. Remove non-skid rubber mat.
3. Align the clip on the rack to the right side of the tray.
4. Line up the holes in the test tube rack to the holes in the tray. Using the screws provided, hand tighten into place using a flathead screwdriver. **DO NOT** over tighten.

#### Installation of 1.5 to 2mL Micro-Tube Rack - Microplate Shaker

1. Unit should be in standby mode.
2. Align the Micro-Tube Rack side-to-side on the tray.
3. Press the Micro-Tube Rack in place, you will hear the Micro-Tube Rack clip into position. No mounting screws are required.

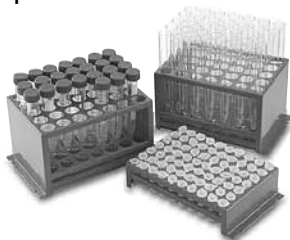

### FLASK CLAMPS

DESCRIPTION	MATERIAL	PLATFORM CAPACITY	PART NUMBER
10mL Erlenmeyer Flask Clamp	stainless steel	35	980078
25mL Erlenmeyer Flask Clamp	stainless steel	20	980079
50mL Erlenmeyer Flask Clamp	stainless steel	15	980080
125mL Erlenmeyer Flask Clamp	stainless steel	12	980081
250mL Erlenmeyer Flask Clamp	stainless steel	6	980082
500mL Erlenmeyer Flask Clamp	stainless steel	4	980083
500mL Media Bottle Clamp	stainless steel	3	980092
125mL Erlenmeyer Flask Clamp	PVC	12	980428
250mL Erlenmeyer Flask Clamp	PVC	6	980429
500mL Erlenmeyer Flask Clamp	PVC	4	980430

#### Installation of Flask Clamps - Orbital Shaker

1. Unit should be in standby mode.
2. Remove non-skid rubber mat.
3. Line up the hole(s) in the flask clamp to the hole(s) in the tray. Using the screw(s) provided, hand tighten into place using a flathead screwdriver. **DO NOT** over tighten.
4. Insert flask/media bottle into clamp and wrap the spring around the neck of the clamp to hold secure.

**Not for use with the Microplate Shaker.**



## ACCESSORIES

### UNIVERSAL HARNESS

DESCRIPTION	MICROPLATE CAPACITY	PLATFORM CAPACITY	PART NUMBER
Universal Harness	2 or 4	1	980192

#### Installation of Universal Harness - Orbital Shaker

1. Unit should be in standby mode.
2. Remove non-skid rubber mat.
3. Insert one band through the side of the "U" in the U-shaped cut-outs on the center post. Pull band through to secure to the U-shaped cut-out. Repeat for the three remaining bands.
4. After the bands are installed in the center post, line up the holes in center post with the two holes in middle of the tray. Using the screws provided, hand tighten into place using a flathead screwdriver. **DO NOT** over tighten.
5. Place the sample(s) on tray.
6. Stretch the harness bands over the sample(s) and then under each of the bent-down corners of the tray.

**Not for use with the Microplate Shaker.**

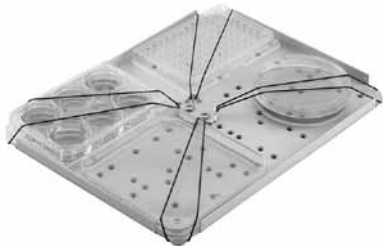

### 2-BAR ADJUSTABLE PLATFORM

The 2-Bar Adjustable Platform has a non-skid rubber surface with adjustable clamping bars to accommodate various vessel types. Stainless steel construction.

DESCRIPTION	SIZE (L x W)	PLATFORM CAPACITY	PART NUMBER
2-Bar Adjustable Platform	11.7 x 8.7" (29.7 x 22.1cm)	1	980197

#### Installation of 2-Bar Adjustable Platform - Orbital Shaker

1. Unit should be in standby mode.
2. Remove non-skid rubber mat.
3. Line up the holes in the 2-Bar Adjustable Platform to the holes in the tray. Using the screws provided, hand tighten into place using a flathead screwdriver. **DO NOT** over tighten.
4. Add glassware. Adjust rollers by loosening each of the thumbscrews. Slide the padded rollers to the desired position and retighten the thumbscrews.

**Not for use with the Microplate Shaker.**



Manufactured by:



201 Wolf Drive • PO Box 87 • Thorofare, NJ 08086 • Phone: 1-888-TALBOYS • Fax: 856-686-1601

E-mail: [troemner@troemner.com](mailto:troemner@troemner.com) • [www.troemner.com](http://www.troemner.com)

715082-00 (REV 6 - 5/15)